

## CUSTOMER INFORMATION

CUSTOMER NAME:	
PO NUMBER:	
JOB NUMBER:	
DATE PRINTED:	6/16/2021
PART NUMBER:	S2442X



## ENGINE SPECIFICATION

MOTOR:	Chevrolet SB	HEAD:	All Pro 13°	COMP RATIO:	14:1	ROD LENGTH:	5.850
MOTOR SIZE:	408	HEAD CC:	49	BLOCK HEIGHT:	9.000	TOP RING RADIAL:	.140
BORE:	4.135	INT VALVE DIA:	2.250	GASKET THK:	9.000	2 <sup>nd</sup> RING RADIAL:	.129
STROKE:	3.800	EXT VALVE DIA:	1.625	DECK CLEARANCE:	.000	OIL RING RADIAL:	.110

## PISTON SPECIFICATION

FORGING#:	X112/X112	DISH/DEPTH:		PIN DIAMETER:	.927
DOME HEIGHT:	.250	CAM PROFILE:	5F55C5L18	PIN FIT TO:	.9285
DOME/DISH VOL:	-4.780	TOP LAND VOL.:	-1.230	PISTON TO CYL CLEAR:	.0045
				PIN LENGTH:	2.250

RING DATA	GROOVE WIDTH		GROOVE DIAMETER	
	INCH	METRIC	INCH	METRIC
TOP RING	.0400	1.016	3.8070	96.6978
2 <sup>ND</sup> RING	.0400	1.016	3.8320	97.3328
OIL RING	.0780	1.9812	3.8550	97.917

VALVE RELIEF	INTAKE		EXHAUST	
	INCH	METRIC	INCH	METRIC
POCKET DEPTH	-.3200	-8.128	SP	SP
POCKET ANGLE	13.000°		13.000°	
POCKET DIA.	2.3500	59.690	1.8000	45.720

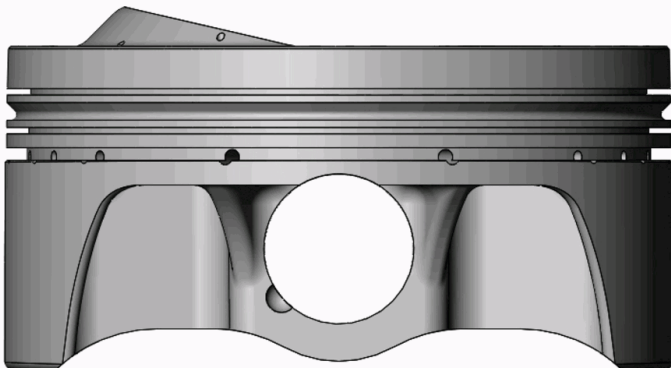

COATINGS:	-
-----------	---

PISTON WEIGHT:	502
----------------	-----

COMPRESSION HEIGHT:	1.250	CENTER OF PIN TO DECK
---------------------	-------	-----------------------

TURN DIA:	4.1305
-----------	--------

GAUGE POINT:	.400	INCHES UP FROM BOTTOM OF SKIRT
--------------	------	--------------------------------